

LS2X Series

Patent product , counterfeiting not allowed

Membrane Key Patent No.: ZL 01 2 03361.8

Insect-proof Patent No.: ZL 03 2 26288.4

Label Printing Scale



Model Explication

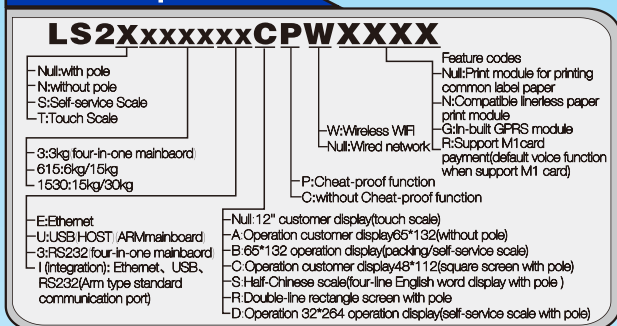

with insect-proof loop design (patent)



removable and renewable hot keypad (Patent)



LS2XR



LS2XC



LS2NX



customer display (back of no-display-pole scale)

Unique Functions

- Web65 cloud software, able to achieve cloud scale function(headquarters unitedly manage branch data) via public network(Carrefour mode)or inner network(VPN,YH mode).
- The first comany in the world introduced cloud label scale functions.
- Originated insect-proof design (patented) in the world, which is able to prevent the machine from damaging insects, especially suitable for seafood department.
- Patented removable and renewable hot keypad (patented, 112*2 keys) design. And PLU keys make it easy and quick to be operated, you don't need to memorize and input the serial commodity numbers, lest long queue in the shop. In addition, the hotkeys can be edited via PC software at any time to meet your needs and printed out immediately.
- Optional linerless label printer module (LS2NX), greatly saving cost and protecting environment when printing linerless label.
- Modularized printer design, easy to be replaced and maintain without professionals. (e.g. Printer module P-1,P-2,)
- Each PLU barcode format and pricing unit can be selected in the scale, flexibly and easily to be used.
- Capable of printing batch serial barcode to carry out batch management of fresh commodity purchasing and the fresh status, this makes it possible to auto-set scheduling decrease price according to the fresh status when changing the price label, so as to avoid rotten once some of the commodity is neglected.
- World originated design based on the idea of POS network management. Exclusive offering PLU manage software, network manage software, label editing software, and 18-code barcode function, which brings fresh foods department to computer management, thus to solve the tough problem that long term exist in fresh commodity management.
- The first Barcode Label Scale compatible with label graphic edit software, which is able to adjust label dimension arrange from 30*30mm to 60*109mm that greatly cut down the label paper cost.

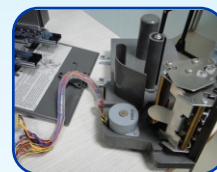

Printer module replacement (P-1)

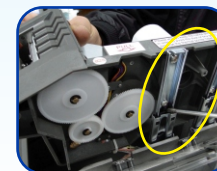

Pull out path (P-2)



Vertical label printing (P-3)



PLU Management

- Different barcode type can be selected for each PLU (e.g. EAN18, EAB8, etc)
- Price of PLU can be inputted temporary by scale keyboard during operation.
- Different Weight Unit can be selected freely for each PLU according to actual usage (e.g. 10g, 50g, 100g, 500g, kg, lb etc)

Back Office Application

- Powerful capacity of logo design (Based on Windows system) allows users to design and download any Logo.
- Powerful capacity of PLU management (similar to Excel) makes the PLU Code, Name, Price and Description can be programmed easily.
- Parameter and Password can be set and download to scale through this Application, to control scale from back office.
- Providing technical file (.DLL) for easily connecting to POS system of supermarket.
- Can be connected to any back office application which based on different system, such as: NT, Unix, Internet and so on.
- Different font can be selected for characters printed in label.

Dimensions

LS2XR

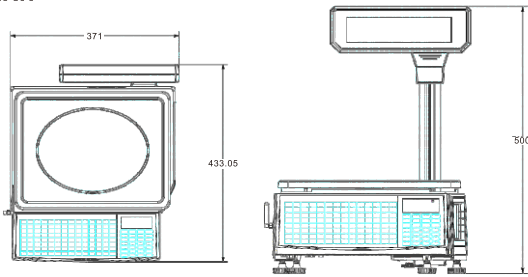

LS2XC

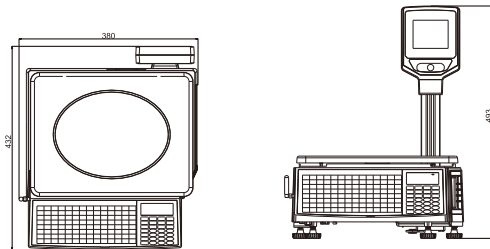

LS2NX

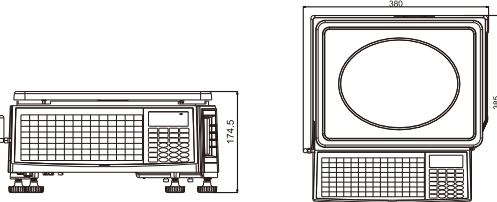

Functions

- Barcode can be printed out vertically or horizontally.
- Print density can be adjusted according to sensitivity of label paper. Moreover, the auto voltage & temperature compensation design prolong the life time of printer 2-3 times.
- Capacity of installing larger label roll (1000 pieces labels)
- Supporting firmware online upgrade.
- Rapidly renew the hotkey according to actual usage requirements.
- Membrane Keyboard can be cleaned simply by wet cloth. High capacity of Anti-dirty.
- Support many languages' display and print, such as: English, Russian, Arabic, Portuguese and Spanish etc.
- Support one barcode multi-products of QR code, save lots of label paper, support to fast cashier and save customer queuing time.

Specifications

Optional types	LS2X		
measuring range	6kg/15kg,15kg/15kg/30kg,30kg		
Scale interval(min.)	2g/5g,5g/5g/10g,10g		
Tare(max.)	-5.998kg,-7.495kg,-14.995kg,-14.995kg		
Internal resolution	1/30000		
Operator display	64*384 with backlight LCD display	48*112 with backlight LCD display	65*132 with backlight LCD display
Customer display	None		
Keyboard	112X2 PLU hotkeys		
Paper	Paper type	thermal paper	
	Paper width(max.)	62mm	
	Roll outside diameter	Max Φ90mm(inner Φ28mm); Max Φ80mm(inner Φ40mm)	
	Valid printing width	56mm	
Printing speed	120mm/s		
Barcode	2/5 interleaved, EAN 13, EAN 128,QR code,GS1 etc.		
Data storage	RAM: 2G SD card		
Optional functions	WiFi, linerless label printing		
Communication interface	RJ45*(Ethernet), RS-232*1		
Power supply	AC 100-240V,50-60HZ		

Label type

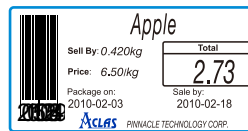

Nutrition Facts	
Serving Size: 6 oz(170g)	
Amount Per Serving	
Calories 122 Cakirues from Fat 37	
	%Daily Value*
Total Fat 8.32g	6%
Saturated Fat 2.14g	5%
Trans Fat	
Cholesterol 64.6mg	11%
Sodium 66.30mg	1%
Potassium 428.4mg	6%
Total Carbohydrate 0g	0%
Dietary Fiber 0g	0%
Sugars 0g	
Sugar Alcohols 0g	
Protein 39.66g	
Vitamin A 3611.10 IU	37%
Vitamin C 0 mg	0%
Calcium 13.6 mg	1%
Iron 1.74g	5%

Note : Functions and appearance are subject to change without notice. Please refer to practicality.

The connection diagram of Broad Band POS Cash Register (Pinnacle exclusive)

